

LAMONA

at the heart of the kitchen

Built-in Single Fan Oven

LAM3412

LAM3413

LAM3414



Instructions and Installation

Register 
my appliance

www.howdens.com/appliance-registration

ISSUE v1.0 141022



Free 3 year guarantee

Call now¹

Within the UK:

0333 010 0009

Within Republic of Ireland:

01525 5752

Alternatively, visit www.howdens.com/appliance-registration

LAMONA

**3 year guarantee available.
Register your appliance within 90 days²**

By registering your appliance and creating an account, we will keep you up to date with the latest product information and notify you immediately of any important product updates

¹Lines are open Monday to Friday 9am to 5pm. Calls will be charged at your local rate and may be recorded and monitored for training and quality purposes.

²So that in the event of an important product update, or recall, we can contact you.

Register 
my appliance

Welcome

Dear Customer,



Congratulations on your choice of oven.

The user manual will help you use your product quickly and safely.

- Please read this user manual before installing and using the oven.
- Always follow the safety instructions.
- Keep this user manual within easy reach for future reference.
- Register your appliance to access a digital copy of your user manual for future reference.
- Please read any other documents supplied with the product.

Explanation of symbols

Throughout this manual the following symbols are used.

	Important information or useful usage tips.
	Warning for possible hazards to health and property.
	Warning possibility of electric shock.

Contents

1. Before using the oven	5	7. Clock Programmer	14
General Safety	5	Minute Minder	14
Safety for children	7	Timer Cooking	14
Safety when working with electricity	7	Delayed Start Cooking	15
General warnings about cooking in the oven	8	8. Key Lock	16
2. Environmental Instructions	9	9. Cooking table	17
Waste regulation	9	Oven cooking table	17
Package information	9	10. Cooking and baking advice	18
Recommendations for energy saving	9	11. Care and maintenance	20
3. General information	10	General information	20
Oven layout	10	Cleaning the control panel	20
Control panel layout	10	Cleaning oven door glass	20
Accessories	10	Removal of the oven door glass	21
4. Operating modes	11	Replacing the oven lamp	21
Oven functions	11	Removing and cleaning wire racks	22
5. Preparation	12	12. Installation	23
First cleaning of appliance	12	Before installation	23
Initial heating	12	Electrical connections	24
Tips for energy saving	12	Cooling fan	26
6. How to operate the main oven and grill	13	13. Technical specifications	27
Setting the correct time	13	14. Troubleshooting	28
Select temperature & operating mode	13	15. Your guarantee	29
How to use the Oven & Grill	13		
Shelf positions	13		

1. Before using the oven

- Make sure that you have removed all packaging, wrappings, stickers and film from the oven's surface and inside the oven cavity (see page 10).
- It is recommended that you clean and wash the oven's surface before using for the first time (page 14).
-  This appliance is for domestic cooking purposes only. It must not be used for other purposes, e.g. room heating, or drying towels and dish cloths over the handle. Commercial use will void the guarantee (see guarantee page).
- The manufacturer shall not be liable for any damage caused by improper use or handling errors.

General Safety

- This product is not intended to be used by persons with physical, sensory or mental disorders or unlearned or inexperienced people (including children) unless they are supervised by a person who will be responsible for their safety or who will instruct them accordingly in the use of the product.
- Connect the product to an earthed outlet protected by a fuse of suitable capacity as stated in the "Technical specifications" table. Our company shall not be liable for any problems arising due to the product not being earthed in accordance with the local regulations.
- Do not operate the product if the power cable is damaged. Call qualified service agent.
- Do not operate the product if it is defective or has any visible damage.
- Do not carry out any repairs or modifications on the product. However, you may remedy issues that do not require any repairs or modifications. See Troubleshooting, later in this booklet.
- Never wash down the product with excessive water, as there is the risk of electric shock!
- Never use the product when your judgment or coordination is impaired by the use of alcohol and/or drugs.
- Product must be disconnected from the mains during installation, maintenance, cleaning and repair procedures.
- **Do not place aluminium foil on the base of the baking tray.**

- Repair procedures must always be performed by qualified service agents. The manufacturer shall not be held responsible for damages arising from procedures carried out by unauthorised persons, which may also void the guarantee.
- Be careful when using alcoholic drinks in your dishes. Alcohol evaporates at high temperatures and may cause fire since it can ignite when it comes into contact with hot surfaces.
- Do not heat closed tins and glass jars in the oven. The pressure that would build-up in the tin/jar may cause it to burst.
- Do not place any flammable materials close to the product as the sides may become hot during use.
- **⚠ WARNING FIRE RISK: Do not place aluminium foil, baking trays or cook on the base of this oven, doing so will cause permanent damage to your appliance and cabinetry with the potential risk of fire.**
- Keep all ventilation slots clear of obstructions, as this may cause premature failure of the oven element.
- Parts of the appliance may become hot during or immediately after use. Care should be taken to avoid touching the heating elements, and components inside the oven which may be hot. Always allow sufficient time for the oven to cool.
- Do not allow the oven to cool with the door open. Even if the appliance door is only open a little, front panels of adjacent units could become damaged over time.
- If the door seal is very dirty this can prevent the door from closing properly during use, resulting in possible damage to adjacent furniture and poor efficiency. Always ensure the door seal is clean.
- Always use heat resistant oven gloves when putting dishes in or removing dishes from the hot oven.
- Do not use the product if any door glass is removed or damaged.
- Rear surface of the oven may get hot when it is in use. Make sure that the electrical connections do not contact the rear surface; otherwise, connections may be damaged.
- Do not trap the mains cable and do not route it over hot surfaces. The cable insulation may melt and cause a fire as a result of a short circuit.
- Make sure that the product function knobs are switched off after every use.



- When hot and cold air meet, condensation can form. The outer door is air cooled and the inner glass will become hot during cooking, therefore some condensation might form. This is perfectly normal. All condensation will disappear as the oven reaches cooking temperature.
- Product must be installed by a qualified person in accordance with the regulations in force. Otherwise, the guarantee may become void.
- Do not use harsh abrasive cleaners or sharp metal scrapers to clean the oven door glass since they can scratch the surface, which may result in shattering of the glass.
- Do not use a steam cleaner for cleaning operations.
-  **WARNING:** Avoid possibility of an electric shock – ensure the appliance is switched off before replacing the lamp.
- The means for disconnection must be incorporated in the fixed wiring in accordance with the wiring rules.
- The instructions state the type of cord to be used, taking into account the temperature of the rear surface of the appliance.
- **Do not switch the oven off at the mains isolation switch immediately after cooking cooling fan continues to run for up to 20-30 minutes approx. even after the oven control is turned off.**

Safety for children

- Electrical products can be dangerous to children under 8 years of age.
- Keep children away from the product when it is operating and do not allow them to play with or near the product.
- **CAUTION:** accessible parts of the oven may become hot when the oven or grill is in use. Children should be kept away until the product has cooled down.
- Do not store any items above the appliance that children may reach for.
- When the door is open, do not load any heavy object on it and do not allow children to sit on it. The door or door hinges may be damaged.
- The packaging materials will be dangerous for children. Keep the packaging materials away from children. Please dispose of all parts of the packaging according to environmental standards.

Safety when working with electricity

- Any work on electrical equipment and systems should only be carried out by authorised or qualified persons.
 - In case of any damage, switch off the product and disconnect it from the mains. To do this, turn off at the fuse box.
 - Make sure that fuse rating is compatible with the product.
-

 **General warnings about cooking in the oven**



WARNING! Risk of fire!

- Do not place aluminium foil or baking trays on the base of the oven when in use. Heat is reflected downwards and can damage the oven and the cabinets beneath.
- Do not line the grill tray or any baking trays with aluminium foil. The reflected heat can damage the heater.



2. Environmental Instructions

Waste regulation

Disposing of the old product. Compliance with the WEEE Directive and disposing of the waste product:

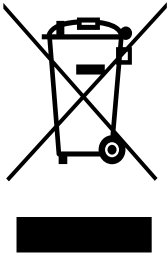

This product complies with EU WEEE Directive (2012/19/EU). This product bears a classification symbol for waste electrical and electronic equipment (WEEE).

This product has been manufactured with high quality parts and materials which can be reused and are suitable for recycling. Do not dispose of the waste product with normal domestic and other wastes at the end of its service life. Take it to the collection centre for the recycling

of electrical and electronic equipment. Please consult your local authorities to learn about these collection centres. Appropriate disposal of used appliance helps prevent potential negative consequences for the environment and human health.

Compliance with RoHS Directive:

The product you have purchased complies with EU RoHS Directive (2011/65/EU). It does not contain harmful and prohibited materials specified in the Directive.

Package information

- Packaging materials of the product are manufactured from recyclable materials in accordance with our National Environment Regulations. Do not dispose of the packaging materials together with the domestic or other wastes. Take them to the packaging material collection points designated by the local authorities.

Recommendations for energy saving

The following suggestions will help you use your product in an ecological and energy-efficient way:

- Defrost frozen food before cooking.
- In the oven, use dark or enamelled containers that transmit heat better.
- Turn off the product 5 to 10 minutes before the end time of cooking for prolonged cooking. Now you can save up to 20% electricity by using heat.
- If specified in the recipe or user manual, always preheat. Do not open the oven door frequently during cooking.

3. General information

Oven layout

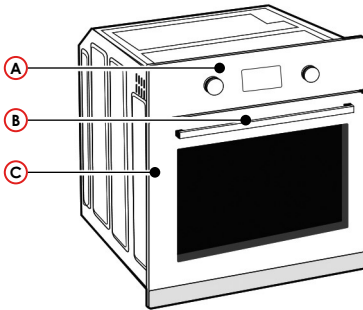

- A** Control panel
- B** Handle
- C** Oven door

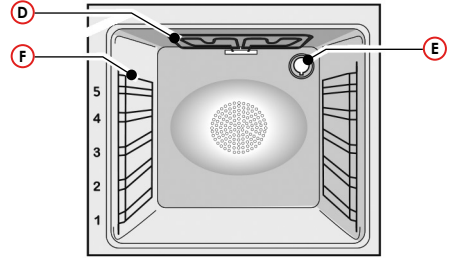

- D** Heating element
- E** Light
- F** Oven shelf position

Control panel layout



- A** Oven / grill function knob
- B** Main oven temperature control knob
- C** Oven / grill temperature indicator

Accessories

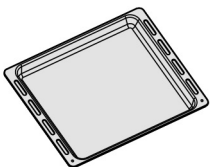

Oven tray / grill pan



Grill pan wire rack / trivet

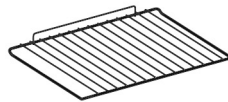

Oven shelf / (x2 included)







Lateral wire grids
(Left / Right)

4. Operating modes

Oven functions

All functions of the ovens and grill are listed in this section. Please note* depending on the model of your oven, the number and order of operating modes available may deviate from the illustrations shown below.

Symbol	Function	Description
	Lamp	Turns on the oven light. This will automatically activate the cooling fan.
 *	Circular Heating Element and Fan	Air that has heated is blown by the fan onto the different levels. It is ideal for cooking different types of food at the same time (e.g. meat and fish) without mixing tastes and smell. It cooks very gently and is ideal for sponge cakes, pastries, etc.
	Grill and Fan	The top heating element is used in conjunction with the fan which circulates the hot air around the oven. Pre-heating is recommended for red meats, but is not necessary for white meats. Grilling is ideal for cooking thicker food items such as pork or poultry. Food to be grilled should be placed directly at the centre of the middle shelf. By sliding the drip tray underneath the shelf it will ensure that any are collected. For results always make sure that the food is not too close to the grill element and turn the food over half way through the cooking time.
	Defrosting	When the dial is set to this position, the fan circulates air at room temperature around the frozen foods so that it defrosts in a few minutes without the protein content of the food being changed or altered.
	Grill	Using the top heating element. Success is guaranteed for mixed grills, kebabs and gratin dishes. The grill should be pre-heated to a high temperature for 4 minutes. White meats should always be placed at some distance from the grill element, the cooking time is slightly longer, but the meat will be more succulent. Red meat and fish fillets can be placed directly onto the shelf with the drip tray placed beneath on the lower shelf position.

*Tested in accordance with the CENELEC EN 60350-1 used for definition of energy class.

5. Preparation

First cleaning of the appliance

1. Remove all packaging materials.
2. Wipe the surfaces of the appliance with a damp cloth or sponge and dry with a clean cloth and mild detergent.

The surface may get damaged by some detergents or cleaning materials.

Do not use aggressive detergents, cleaning powder / cream or any sharp objects or abrasives.

Initial heating

It is recommended to heat up the product for about 30 minutes and then switch it off. Thus, any production residues or layers will be burnt off and removed.

1. Take the tray and the wire grid out of the oven.
2. Close the oven doors.
3. Select the highest oven & grill power levels (See How to use the oven and grill section).
4. Operate oven & grill for about 30 minutes.
5. Turn off your oven & grill and allow to cool.



Small amounts of fumes may emit during the initial heating process; this is normal, however monitor the oven at all times and ensure that the room is well ventilated.

Tips for saving energy

The following information will help you to use your appliance in an ecological way, and to save energy:

- Use dark coloured or enamel coated cookware in the oven as the heat transmission will be better.
- Perform a preheating operation if it is advised in the user manual or cooking instructions. Do not open the door of the oven frequently during cooking.
- Try to cook more than one dish in the oven at the same time whenever possible. You can place two cooking vessels onto the wire shelf.
- Cook one dish after another. The oven will already be hot.
- You can save energy by switching off your oven a few minutes before the end of the cooking time. Do not open the oven door.
- Defrost frozen dishes before cooking them if possible if applicable.

6. How to operate the main oven and grill

Setting the correct time ⌚





WARNING: The oven will not operate until clock is set.

When first switched on the clock display will flash '12.00'.

Touch the + or – buttons whilst the display is flashing to adjust the time. (The display stops flashing after 5 sec and time is displayed).

To adjust clock time:

Press mode button  x 4 times until clock symbol  is displayed. Touch the + or – buttons whilst display is flashing to set the time of day. (The display stops flashing after 5 sec and time is displayed).

Select temperature & Operating mode

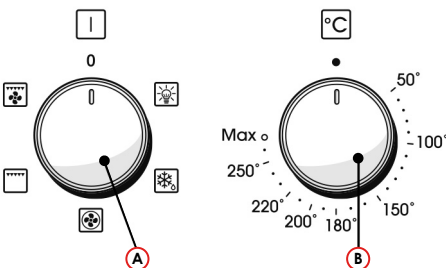

- A** Oven / grill function knob
- B** Oven / grill thermostat knob

The operating modes of the electric oven are selected with the function knob. The temperature is adjusted with the thermostat knob.

How to use the Oven & Grill

1. Close the oven door
2. Set thermostat knob to the desired temperature
3. Set function knob to the required operating mode

The oven heats up to the adjusted temperature and maintains it. During heating, the temperature indicator light will remain on until the desired temperature is reached.

Shelf positions

The oven has 5 shelf positions as illustrated below, it is important to position the wire shelf into the runners correctly.

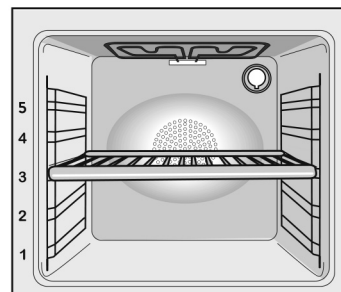

⚠ Please ensure shelves are fully inserted before closing the oven door, failure to do so could lead to damage to the door.

Warning - Do not place aluminium foil or baking trays on the bottom of oven cavity. This can lead to permanent damage to your appliance.

Warning - Do not place plates, dishes or trays on the bottom of oven cavity when oven is in use.

Warning - Do not use the oven or grill cavity for storage when not in use.



Switch off the electric oven

Turn function knob and thermostat knob to off position (top).

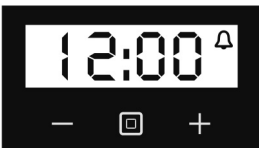

7. Clock Programmer

Minute Minder (0.01 min - 23.59hr)



Press mode button  x 1 time until alarm symbol  is displayed. Touch the + or - buttons to set the desired time duration. The alarm will sound when the selected time has elapsed. Touch any button to stop alarm.

To cancel:



Press mode button  x 1 time until alarm symbol  is flashing. Touch the + or - buttons to set the duration to 00.00.

Timer Cooking

Timed Operation Period

Oven cooks for a selected time period then stops: (0.01 min to 23.59hr)



Press mode button  x 2 time until Cook symbol  is displayed and flashing.

Touch the + or - buttons to set the desired cooking time duration. (Display reverts to time of day after desired time period is set and  + **A** symbol remains lit).

Select desired oven cooking mode and temperature using the oven control knobs.

The alarm will sound and the Cook symbol  will flash when the selected cooking time has elapsed.

Turn oven control knobs to 'Off' and touch any button to stop alarm and return over to 'Manual' use mode.

To check time left:

Press mode button  x 2

To Cancel:

Press mode button  x 1 time until Cook symbol  is displayed.

Touch the + or - buttons until alarm sounds and display shows 00.00.

Clock time returns.

Note: Whilst cook symbol  is flashing, the oven cannot be used in 'Manual' mode.

Time Stop Point

Oven cooks until a designated time then stops: (up to 23.59hr)



Press mode button  x 3 times until symbol **A** is displayed and flashing.

Touch the + or - buttons to set the desired stop time. (Displayed reverts to time of day after desired stop time is set and **A** +  symbol remains lit).

Select desired oven cooking mode and temperature using the oven control knobs.

The alarm will sound and the  symbol will flash when the selected time has been reached.

Turn oven control knobs to 'Off' and touch any button to stop alarm and return to 'Manual' use mode. (Timer will sound for 2 mins then stop if no button is pressed).

To cancel:

Press mode button  x 3 times until **A** symbol is flashing.

Touch the + or - buttons until alarm sounds and time of day returns.

Delayed Start Cooking

The two timed cooking modes can be combined to create a delayed start cooking period.

Programme a Timed Operation Period (as described on p12).

Then

Programme a Time Stop Point (as described on p12).

Both symbols **A** and  will be displayed and the cooking process will start at a future point in time e.g.

If Time Stop Point is set to 16.00 and Timed Operation Period is set to 1.30 hrs - the oven will switch on at 14.30 and cook until 16.00.

To Check Settings:

Push mode button  x 2 to see  cooking period.

Push mode button  x 3 to see **A** cooking end time.

To cancel:

Press mode button  x 2 time until Cook symbol  is displayed.

Touch the + or - buttons until alarm sounds and display shows 00.00 Clock time returns.

8. Key Lock

How To Use

Child Lock function is activated by touching Set + for a minimum of 5 seconds. From this moment on all other functions are locked and the display will flash **STOP** and preset time intermittently.



To set Child Lock function:

Press set + for a minimum of 5 seconds.

Display will then flash **STOP**

How To Deactivate

Child Lock function is deactivated by touching touchpad. Set + again for a minimum of 5 seconds. From this moment on all functions are selectable again.

















9. Cooking table







 The values indicated in the tables below are indicative. They may vary according to the type food, the quantity and your preferences of cooking.

Baking and roasting

Level 1 is the lowest shelf level.

Oven cooking table

Dish	Cooking level number	Oven Function	Rack position	Accessories	Temperature (°C)	Cooking time (min) (approx.)
Cakes in tray	One level		3	Oven Tray	175	30 - 40
	2 levels		2 - 3	Oven Tray	175	45 - 60
Cakes in mould	One level		2	Oven Tray	175	50 - 60
Small cakes	One level		3	Oven Tray	170	25 - 35
	2 levels		1 - 3	Oven Tray	170	35 - 45
	3 levels		1 - 3 - 5	Oven Tray	170	35 - 45
Sponge cake	One level		3	Oven Tray	200	15 - 20
Cookies	One level		3	Oven Tray	175	25 - 30
	2 levels		2 - 3	Oven Tray	170 - 190	35 - 45
	3 levels		1 - 2 - 3	Oven Tray	175	30 - 40
Dough pastry	One level		3	Oven Tray	200	35 - 45
	2 levels		2 - 3	Oven Tray	200	50 - 60
	3 levels		1 - 2 - 3	Oven Tray	200	55 - 65
Filled savoury pastry	One level		3	Oven Tray	200	25 - 35
	2 levels		2 - 3	Oven Tray	200	35 - 45
	3 levels		1 - 2 - 3	Oven Tray	190	45 - 55
Leaven	One level		3	Oven Tray	200	35 - 45

Dish	Cooking level number	Oven Function	Rack position	Accessories	Temperature (°C)	Cooking time (min) (approx.)
Lasagne	One level		3	Oven Tray	200	30 - 40
Beefsteak (whole)/Roast	One level		3	Oven Tray	Start 250, after 25 mins change to 180 - 190	100 - 120
Lamb haunch casserole	One level		3	Oven Tray	Start 220, after 25 mins change to 180 - 190	70 - 90
Roast chicken	One level		2	Oven Tray	Start 250, after 15 mins change to 190	55 - 65
Turkey (5.5kg)	One level		1	Oven Tray	Start 250, after 25 mins change to 190	150 - 210
Fish	One level		3	Oven Tray	200	20 - 30

While cooking with 2 trays at the same time, place the deep tray to the upper shelf and shallow tray to the lower shelf.

It is suggested to perform preheating for all foods.

10. Cooking and baking advice

 Risk of scalding by hot steam! Take care when opening the oven door as steam may escape.

Tips for baking

- Use non-stick coated appropriate metal trays and containers or heat-resistant silicone moulds.
- Make best use of the space on the shelf.
- It is recommended to place the vessels in the middle of the shelf.
- Select the correct shelf position before turning the oven or grill on – don't move oven shelves when hot.
- Keep the oven door closed.

Tips for roasting

- Seasoning with lemon juice and black pepper will improve the cooking performance when cooking a whole chicken, turkey or a large piece of meat.
- Meat with bones takes about 15 to 30 minutes longer to cook than a roast of the same size without bones.
- Let meat rest in the oven for about 10 minutes after the cooking time. The juices will be better distributed throughout the meat and will not run out when the meat is cut.
- Fish in a heat proof dish should be placed at the medium or lower level.

Tips for grilling

- Grilling is ideal for cooking meat, fish and poultry and will achieve nice browning without drying out the food. Flat pieces, meat skewers and sausages are particularly suited for grilling, as are vegetables with a high water content, such as tomatoes and onions. Distribute the pieces to be grilled on the wire rack.
- Use tray or grill pan under the wire rack in order to collect dripping fat or juices.
- Adding some water to the grill pan will assist with cleaning.

Tips for baking cake

- If the cake is too dry, increase the temperature by 10 °C and decrease the cooking time.
- If the cake is wet, use less liquid or lower the temperature by 10 °C.
- If the cake is too dark on top, place it on a lower shelf, lower the temperature and increase the cooking time.
- If cooked well on the inside but sticky on the outside use less liquid, lower the temperature and increase the cooking time.

Tips for baking pastry

- If the pastry is too dry, increase the temperature by 10 °C and decrease the cooking time. Dampen the layers of pastry with a wash composed of milk, oil, egg.
- If the pastry takes too long to bake, pay attention to the thickness of the pastry you have prepared.
- If the upper side of the pastry gets browned, but the lower part is not cooked, make sure that the amount of wash you have used for the pastry is not too much at the bottom of the pastry. Try to spread the wash equally over the pastry for an even browning.
- Cook the pastry in accordance with the mode and temperature given in the cooking table.

Tips for cooking vegetables

- If the vegetable dish runs out of juice and gets too dry, cook it in a dish with a lid instead of an open tray. Closed vessels will preserve the juice of the dish.
- If a vegetable dish is not cooked, boil the vegetables beforehand.

11. Care and maintenance

General information

Service life of the product will extend and the possibility of problems will decrease if the product is cleaned at regular intervals.



Risk of electric shock!

Switch off the electricity before cleaning appliance to avoid possibility of an electric shock.



Hot surfaces may cause burns!

Allow the appliance to cool down before you clean it.

- Clean the product thoroughly after each use. This way it will be possible to remove cooking residues more easily and will avoid burning them on the next time the appliance is used.
- No special cleaning agents are required for cleaning the product. Use warm water with washing liquid, a soft cloth or sponge to clean the product and wipe with a dry cloth.
- Always ensure any excess liquid is thoroughly wiped off after cleaning and any spillage is immediately wiped dry.

- Do not use cleaning agents that contain acid or chloride to clean the stainless steel surfaces and the handle.
- Use a soft cloth with a liquid detergent (not abrasive) to wipe those parts clean, paying attention to sweep in a horizontal direction.



The surface may be damaged by some detergents or cleaning materials.

DO NOT use aggressive detergents, abrasive cleaning powder / cream or any sharp objects.

DO NOT use steam cleaners for cleaning.

Cleaning the control panel

Clean the control panel and control knobs with a damp cloth and wipe them dry.



DO NOT remove the control knobs for control panel cleaning.

Cleaning oven door glass

Don't use any harsh abrasive cleaners or sharp metal scrapers for cleaning the oven door. They could scratch the surface and damage the glass.

Removal of the oven door glass

1. Open the door.
2. Unlock the door by moving the clips at the hinge: lift and move backwards as illustrated below:

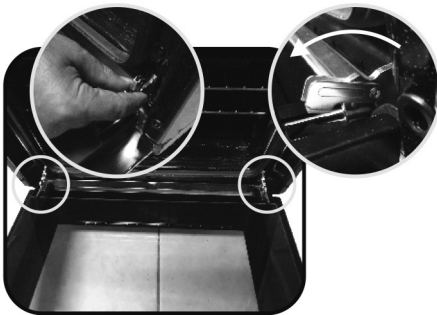

3. Remove the screws as shown below:

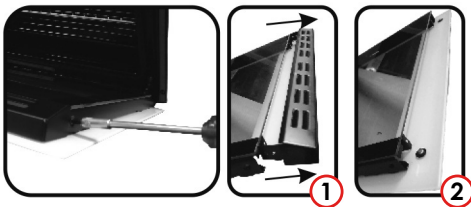

4. Remove the top cover by pulling it upwards **1** leaving the inner glass free to remove **2**
5. Remove the glass by gently pulling it out of the frame and clean.

Do not place the door or inner glass panel on rough or hard surfaces. Handle with care during removal, cleaning and refitting.

Steps carried out during removing process should be performed in reverse order to replace the glass.

-  Do not forget to lock the clips at the hinges when cleaning is complete.

Replacing the oven lamp

-  **Hot surfaces may cause burns!**

Make sure that the appliance is switched off and cooled down in order to avoid the risk of an electric shock or burns.

-  The oven lamp is a special electric lamp that can resist up to 300° C. See Technical specifications, for details.

-  Position of lamp might vary from the diagram.

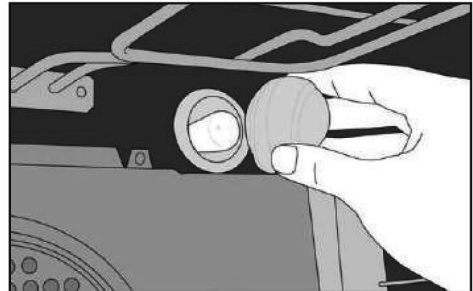

1. Disconnect the oven from the mains.
2. Turn the glass cover counter clockwise to remove it.
3. Remove the oven lamp by turning it counter clockwise and replace it with the new one.
4. Install the glass cover.

Removing and cleaning wire racks

1. Remove the wire racks by pulling them in the direction of the arrows (see below)
2. To clean the wire racks either put them in the dishwasher or use a wet sponge, ensuring that they are dried afterwards.
3. After the cleaning process install the wire racks in reverse order.

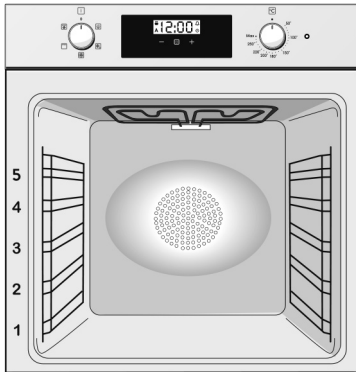

12. Installation

Before installation

The product must only be installed by suitably qualified persons.

 The product must be installed in accordance with all local regulations.

 Prior to installation, visually check the product for any damage / defects. Do not install if any issues are found.

Damaged products may cause risks to your own safety.

- The appliance is intended for installation in Howdens kitchen cabinets.
- Surfaces, synthetic laminates and adhesives used must be heat resistant.
- Kitchen cabinets must be set level and fixed.
- If there is a drawer beneath the oven, a shelf must be installed between oven and drawer.
- The following installation drawings are representational and may not match exactly with your appliance.

Tower Installation

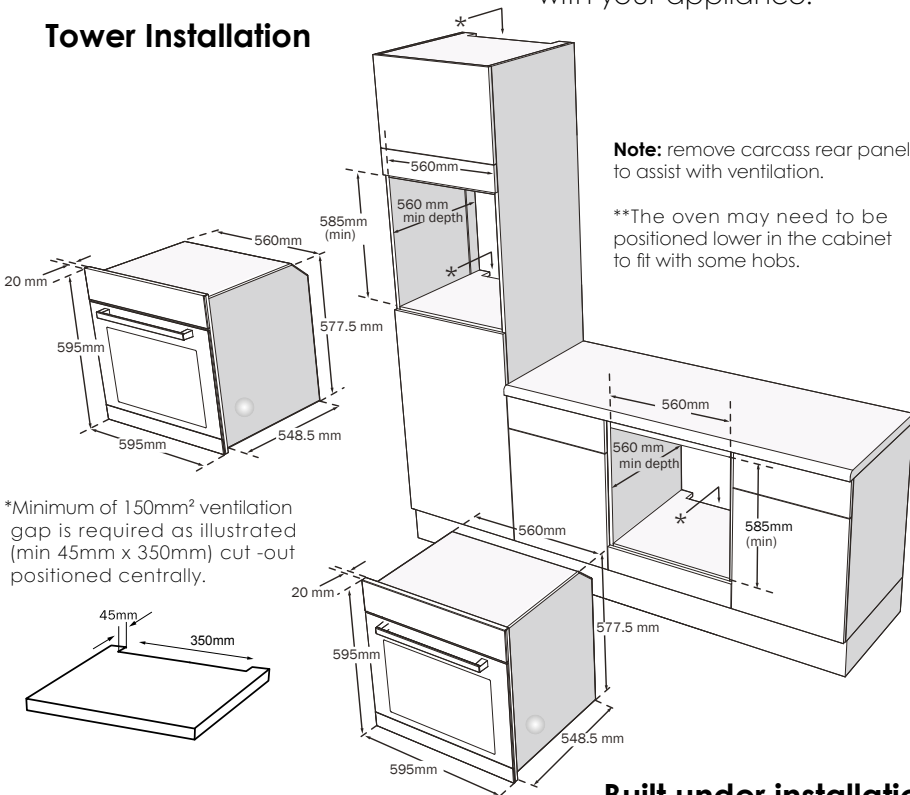



Built under installation

Electrical connections

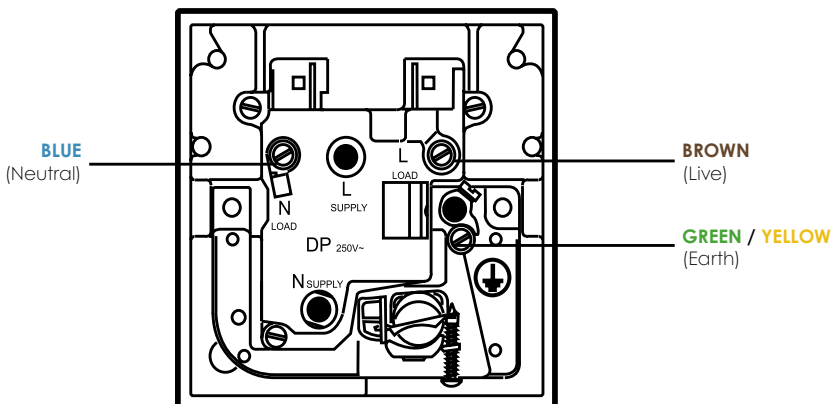
- **⚠ IMPORTANT:** Ensure that the electricity supply is switched off before connecting. Your oven is intended for permanent installation.
- Your appliance must be connected to fixed wiring via the use of a double pole switched fused spur outlet with at least 3mm contact separation. The isolation switch must be accessible after installation (see technical data for fuse rating). We recommend the use of an RCD device as additional protection.
- We strongly recommend the appliance is connected by a qualified electrician who will comply with the I.E.E and any local regulations.
- The terminology DOUBLE POLE - / + means that both the live and neutral supplies are switched and disconnected at the same time.
- The terminations labelled SUPPLY are connections for the internal house wiring and the terminations labelled LOAD are for connection to the appliance.
- **⚠ IMPORTANT:** The wires in the mains lead are coloured in accordance with the following;
 - BLUE** = Neutral
 - BROWN** = Live
 - GREEN / YELLOW** = Earth
- As the colours of the wires in the mains lead of this appliance may not correspond with the coloured markings identifying the terminals in your spur box, proceed as follows;
 - The wire which is coloured blue must be connected to the terminal which is marked with the letter 'N' or coloured 'BLACK'. The wire which is coloured brown must be connected to the terminal which is marked with the letter 'L' or coloured RED. The green and yellow earth 'E' should be connected to the terminal marked with the following symbol .



 The appliance may be connected to the mains supply only by a suitably qualified person. The mains lead must not be clamped, bent, trapped, or come into contact with hot parts of the appliance.

 If the mains lead is damaged, it must be replaced by a qualified person (mains cable must not be longer than 2m for safety reasons). It should be routed away from the appliance and not trapped between the appliance and the wall.

Your oven comes pre-fitted with a mains cable. If you need to change it:

 **Warning: Do not fit plug**

1. Open the terminal block cover with screwdriver.
2. Pass the mains lead under the cable clamp and secure clamp with the screw over the outer cable insulation.
3. Connect the cables according to the supplied diagram.
4. Close the cover of the terminal block once the wiring is complete.
5. Mains cable must not be longer than 2 metres for safety reasons.
6. The mains lead should be routed away from the appliance and not be trapped between the appliance and the wall.

Installation

Slide the oven into the cabinet aperture, align and secure.

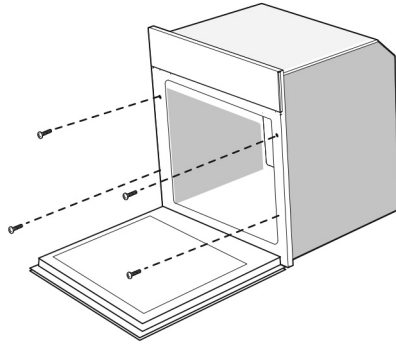

Fix your oven with 4 screws and retainers.

Final check

Connect the appliance to the mains supply, switch on the mains supply and check the oven's functions.

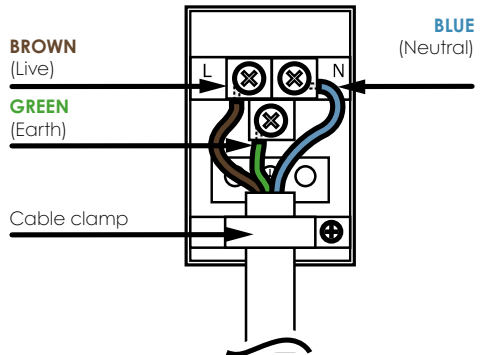

Cooling fan

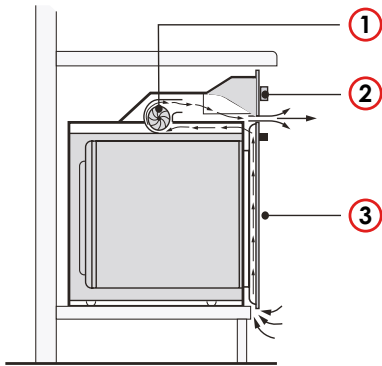

- ① Fan
- ② Control panel
- ③ Door

The Built-in cooling fan cools both the front of the appliance and cabinetry.



⚠ Do not switch the oven off at the mains isolation switch immediately after cooking. Cooling fan continues to run for up to 20-30 minutes (approx.) even after the oven control is turned off.

13. Technical specifications

Technical information	
General	
Voltage / frequency	220-240 V ~ 50 / 60 Hz
Total power consumption	2.4 kW
Fuse	min. 14A
Oven / grill	
External dimensions (height / width / depth)	595mm / 595mm / 548.5mm
Installation dimensions (height / width / depth)	585-595mm / 560 mm / min. 560mm
Main oven	Fan Oven
Energy efficiency class#	A
Energy consumption	0.80 kW/h
Inner lamp	240 V / 15-25 W / E14 SES / T 300°C
Mains Cable	HO5VV-F 1.5 mm ² (1.5 m)

#Basics: Information on the energy label of electrical ovens is given in accordance with the EN 60350-1 standard. Those values are determined under standard load with bottom-top heater or fan assisted heating (if any) functions.

Energy efficiency class is determined in accordance with the following prioritization depending on whether the relevant functions exist on the product or not. 1-Cooking with eco-fan, 2 - Turbo slow cooking, 3 - Turbo cooking, 4 - Fan assisted bottom/top heating, 5 -Top and bottom heating.

-  Technical specifications may be changed without prior notice to improve the quality of the product.
-  Figures in this manual are schematic and may not exactly match your product.
-  Values stated on the product labels or in the documentation accompanying it are obtained in laboratory conditions in accordance with relevant standards. Depending on operational and environmental conditions of the product, these values may vary.

14. Troubleshooting

Troubleshooting guide		
Symptoms	Possible cause	Solutions
Oven emits steam when it is in use.	<ul style="list-style-type: none"> Food is being cooked with a high water content. 	It is normal that steam escapes from food during cooking. This is not a fault.
Product emits metal noises while heating and cooling.	<ul style="list-style-type: none"> When the oven cavity heats up or cools down parts will expand and contract. 	This is quite normal and the oven is designed to accommodate such movement (this is not a fault).
Product does not operate.	<ul style="list-style-type: none"> The mains fuse is maybe defective or has tripped. Product is not connected properly. Check all power connections. 	Check fuses in the fuse box. If necessary, replace or reset them.
Oven light does not work.	<ul style="list-style-type: none"> Oven bulb is defective. Replace oven bulb. Power is cut 	Check if there is power. Check the fuses in the fuse box. If necessary, replace or reset the fuses.
Oven does not heat.	<ul style="list-style-type: none"> Function and / or temperature are not set. The timer is not adjusted correctly. Reset the oven timer. Power is cut 	Set the function and the temperature with the Function and/or Temperature knob/key. Check if there is power. Check the fuses in the fuse box. If necessary, replace or reset the fuses.
No reaction of the touch user interface	<ul style="list-style-type: none"> Steam and condensation on the user interface panel 	Clean with a microfibre cloth the user interface panel to remove the condensation layer
Display shows 'STOP'	<ul style="list-style-type: none"> Child lock active 	See page 16
Condensation on door or control panel	<ul style="list-style-type: none"> Expected in normal function. Not a product fault. 	No action required
Test error code	<ul style="list-style-type: none"> Possible timer fault 	Call the Lamona Service line on 0344 460 0006



If you cannot eliminate the problem after following the instructions in this section, consult your depot or the Authorised Service Agent. Never try to repair a non-functional product yourself.

15. Your guarantee

Product Guarantee Details (UK and Republic of Ireland only)

Your appliance has the benefit of a comprehensive manufacturer's guarantee which covers the cost of breakdown repairs. (Details of which are shown on your Proof of Purchase Document).

- Any claim during the period of the guarantee **MUST BE ACCOMPANIED BY THE PROOF OF PURCHASE.**
- The product must be correctly installed and operated in accordance with the manufacturer's instructions and used for normal domestic purposes.
- This guarantee does not cover accidental damage, misuse or alterations which are likely to affect the product.
- The guarantee is invalid if the product is tampered with, or repaired by any unauthorised person. *(The guarantee in no way affects your statutory or legal rights).*

What to do if you need to report a problem

Please ensure you have ready:

- The product's model and serial numbers.
- Howdens Proof of Purchase Document.
- Your full contact details.

Call the Depot number on your Proof of Purchase Document supplied with the product/kitchen.

or

Call the LAMONA Service Line on:

Within the UK: 0344 460 0006

Within Republic of Ireland: 01525 5703

- Product installed within a domestic kitchen or a non-domestic kitchen where 8 or fewer people are using the appliance.

Where to find model and serial number on your appliance.	Open door on panel just below door seal.
--	--

Spare Parts availability – 10 years

Only fit Genuine Spare Parts

www.lamonaspares.co.uk (UK only)

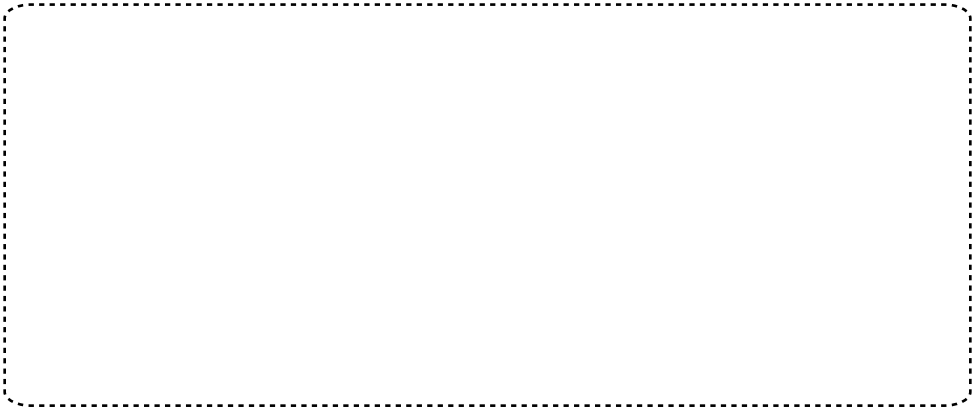

Product serial number
(Place sticker here)

LAMONA

at the heart of the kitchen



FR

Cet appareil
se recycle

REPRISE
À LA LIVRAISON



OU

À DÉPOSER
EN MAGASIN



OU

À DÉPOSER
EN DÉCHÈTERIE



Points de collecte sur www.quefairedemesdechets.fr
Privilégiez la réparation ou le don de votre appareil!

Howden Joinery Ltd, Thorpe Road, Howden, East Yorkshire, DN14 7PA

Imported in EU by: Houdan Cuisines SAS, Z.A. du Bois Rigault Nord,
1Rue Calmette, 62880 Vendin-le-Vieil, Cedex, France.

Product information correct at the time of publication in March 2022.
The company has a policy of continuous product development and
reserves the right to change any products and specifications given in
this manual. Subject to the Terms and Conditions of Trading, a copy of
the Howdens Terms and Conditions is available upon request.

Copyright © 2022 Howden Joinery Ltd. All rights reserved.