

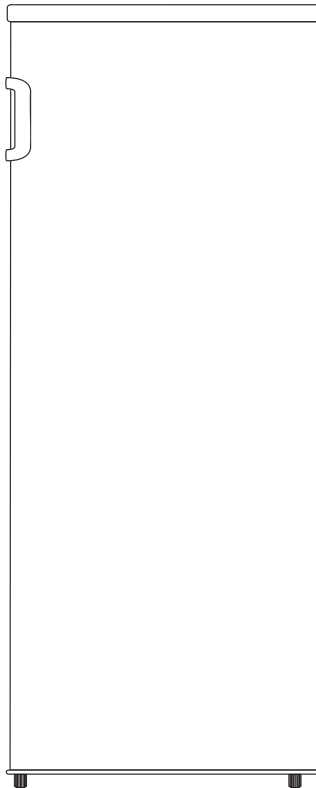

How to use your new Larder Fridge

Model MTL55300



Contents

Safety and warning information_____	2	Cleaning and Care _____	9
Control panel_____	7	Troubleshooting _____	10
First use and Installation _____	7	Description of the appliance _____	12
Operation_____	8	Reversing the door _____	12
Helpful hints and tips_____	9	Disposal of the appliance _____	14



This appliance is in accordance with the following EU guidelines: [2014/35/EU](#) and [2014/30/EU](#) and 2009/125/EC and EC.643/2009 and 2002/96/EC



Safety and warning information

For your safety and correct usage, before installing and first using the appliance, read this user manual carefully, including its hints and warnings. To avoid unnecessary mistakes and accidents, it is important to make sure that all people using the appliance are thoroughly familiar with its operation and safety features. Save these instructions and be sure that they remain with the appliance if it is moved or sold, so that a using it throughout its life will be properly informed on its correct appliance usage and safety.

For the safety of life and property, keep the precautions of these user's

instructions as the manufacturer is not responsible for damages caused by omission.

Safety for children and others who are vulnerable people

- This appliance can be used by children aged from 8 years and above and persons with reduced physical, sensory or mental capabilities or lack of experience and knowledge if they have been given supervision or instruction concerning use of the appliance in a safe way and understand the hazards involved. Children shall not play with the appliance. Cleaning and user maintenance shall not be made by children without supervision.
- Keep all packaging away

from children as there is risk of suffocation.

- If you are discarding the appliance, pull the plug out of the socket, cut the connection cable (as close to the appliance as you can) and remove the door to prevent children playing from suffering an electric shock or from closing themselves inside it.
- If this appliance, featuring a magnetic door seals, is to replace an older appliance having a spring lock (latch) on the door or lid, be sure to make the spring lock unusable before you discard the old appliance. This will prevent it from becoming a death trap for a child.

General safety



- **WARNING** — This appliance is intended to be used in household and similar applications such as
 - staff kitchen areas in shops, offices and other working environments;
 - farm houses and by clients in hotels, motels and other residential type environments;
 - bed and breakfast type

environments;

-catering and similar non-retail applications

- **WARNING** — Do not store explosive substances such as aerosol cans with a flammable propellant in this appliance.
- **WARNING** — If the supply cord is damaged, it must be replaced by the manufacturer, its service agent or similarly qualified persons in order to avoid a hazard.
- **WARNING** — Keep ventilation openings, in the appliance enclosure or in the built-in structure, clear of obstruction.
- **WARNING** — Do not use mechanical devices or other means to accelerate the defrosting process, other than those recommended by the manufacturer.
- **WARNING** — Do not damage the refrigerant circuit.
- **WARNING** — Do not use electrical appliances inside the food storage compartments of the appliance, unless they are of the type recommended by the manufacturer.

- **WARNING** — The refrigerant and insulation blowing gas are flammable. When disposing of the appliance, do so only at an authorized waste disposal centre. Do not expose to flame.

Refrigerant

The refrigerant isobutene (R600a) is contained within the refrigerant circuit of the appliance, a natural gas with a high level of environmental compatibility, which is nevertheless flammable. During transportation and installation of the appliance, ensure that none of the components of the refrigerant circuit becomes damaged.

The refrigerant (R600a) is flammable.



Caution: risk of fire

If the refrigerant circuit should be damaged:

- Avoid opening flames and sources of ignition.
- Thoroughly ventilate the room in which the appliance is situated.

It is dangerous to alter the specifications or modify this product in any way.

Any damage to the cord may cause a shortcircuit, fire, and/or electric shock.



Electrical safety

1. The power cord must not be lengthened.
2. Make sure that the power plug is not crushed or damaged. A crushed or damaged power plug may overheat and cause a fire.
3. Make sure that you can access the main plug of the appliance.
4. Do not pull the main cable.
5. If the power plug socket is loose, do not insert the power plug. There is a risk of electric shock or fire.
6. You must not operate the appliance without the interior lighting lamp cover.
7. The fridge is only applied with power supply of single phase alternating current of 220~240V/50Hz. If fluctuation of voltage in the district of user is so large that the voltage exceeds the above scope, for safety sake, be sure to apply A.C. Automatic voltage regulator of more than 350W to the fridge. The fridge must employ a special power socket instead of common

one with other electric appliances. Its plug must match the socket with ground wire.

Daily use

- Do not store flammable gass or liquids in the appliance, There is a risk of an explosion.
- Do not operate any electrical appliances in the appliance(e.g.electric ice cream makers,mixers etc.).
- When unplugging always pull the plug from the mains socket,do not pull on the cable.
- Do not place hot items near the plastic components of this appliance.
- Store pre-packed frozen food in accordance with the frozen food manufacture's instructions.
- The appliances manufactures storage recommendations should be strictly adhered to.Refer to relrelevant instructions for storage.

- Frozen food can cause frost burns if consumed straight from the freezer compartment.
- Do not place the appliance in direct sunlight.
- Keep buring candles,lamps and other items with naked flames away from the appliance so that do not set the appliance on fire.
- The appliance is intended for keeping food stuff and/or beverages in normal household as explained in this instruction booklet .
- The appliance is heavy.Care should be taken when moving it.
- Do not remove nor touch items from the freezer compartment if your hands are damp/wet,as this could cause skin abrasions or frost/freezer burns.
- Never use the base, drawers, doors etc. to stand on or as supports.
- To avoid items falling and causing injury or damage to the appliance, do not overload the door racks or put too much food in the crisper drawers.

caution!

Care and cleaning

- Before maintenance, switch off the appliance and disconnect the mains plug from the mains socket.
- Do not clean the appliance with metal objects, steam cleaner, ethereal oils, organic solvents or abrasive cleansers.
- Do not use sharp objects to remove frost from the appliance. Use a plastic scraper.

Installation Important!

- For electrical connection carefully, follow the instructions given in this manual.
- Unpack the appliance and check if there are damages on it. Do not connect the appliance if it is damaged. Report possible damages immediately to the place you bought it. In this case retain packing.
- It is advisable to wait at least four hours before connecting the appliance to allow the oil to flow back in the compressor.
- Adequate air circulation should be around the appliance, lacking this leads

to overheating. To achieve sufficient ventilation, follow the instructions relevant to installation.

- Wherever possible the back of the product should be against a wall to avoid touching or catching warm parts (compressor, condenser) to prevent the risk of a fire, follow the instructions relevant to installation.
- The appliance must not be locate close to radiators or cookers.
- Make sure that the mains plug is accessible after the installation of the appliance.

Service

- Any electrical work required to do the servicing of the appliance should be carried out by qualified electrician or competent person. This product must be serviced by an authorized
- Service Center, and only genuine spare parts must be used.
 - 1) If the appliance is Frost Free.
 - 2) If the appliance contains freezer compartment.

Control panel

Starting up and temperature regulation

- Insert the plug of the connection lead into the plug socket with protective earth contact. When the refrigerator compartment door is opened, the internal lighting is switched on.
- The temperature selector knob is located on the RH side of the refrigerator compartment.

Setting "0" means: Off

Turning clockwise in direction Refrigerating unit on, the latter then operating automatically.

Setting "1" means: Highest temperature, warmest setting. Setting "7" (end-stop) means: Lowest temperature, coldest setting.

At a low ambient temperature of around 16 °C, setting 1 should be selected. At ambient temperatures of around 25 °C, select setting 2. If you require a lower temperature, select setting 3 or 4.

Important! Normally we advise you select setting of 2 or 3 or 4, if you want the temperature warmer or colder please turn the knob to lower or higher setting accordingly. When you turn the knob to lower which can lead to the more energy efficiency. Otherwise, it would result the energy-consuming.

Important! High ambient temperatures (e.g. on hot summer days) and a cold setting (position 6 to 7) may cause the compressor to run continuously or even non-stop!

Reason: when the ambient temperature is high, the compressor must run continuously to maintain the low temperature in the appliance

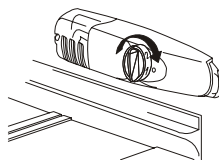

First use and Installation

Cleaning before use

- Before using the appliance for the first time, wash the interior and all internal accessories with lukewarm water and some neutral soap so as to remove the typical smell of a brand new product, then dry thoroughly.

Important! Do not use detergents or abrasive powders, as these will damage the finish.

Installation Positioning



Warning! Before installing, read the instruction carefully for your safety and correct operation of the appliance.

- Position the appliance away from sources of heat such as stoves, radiators, direct sunlight etc.
- Maximum performance and safety are guaranteed by maintaining the correct indoor temperature for the class of unit concerned, as specified on the rating plate.

- This application perform well from **N to T**. The Appliance may not work properly if it is left for a longer period at a temperature above or below the indicated range.

Important! There is a need of good ventilation around the fridge for easy dissipation of heat, high efficiency of refrigeration and low power consumption. For this purpose, sufficient clear space should be available around the fridge. It is advisable for there to be 75mm separating the back of the fridge to the wall, at least 100mm of space at its two sides,height of over 100mm from its top and a clear space upfront to allow the doors to open 160°.

Climate class	Ambient temperature
SN	+10°C to +32°C
N	+16°C to +32°C
ST	+16°C to +38°C
T	+16°C to +43°C

- Appliances must not be exposed to rain.

Sufficient air must be allowed to circulate in the lower rear section of appliances, as poor air circulation can affect performance. Built-in appliances should be positioned away from heat sources such as heaters and direct sunlight.

Leveling

- The appliance should be level in order to eliminate vibration. To make the appliance level, it should be upright and both adjusters should be firmly contacted with the floor. You can also adjust the level by screwing out the appropriate level adjuster at the front (use your fingers or a suitable spanner).

Electrical connection

Caution! Any electrical work required to install this appliance should be carried out by a qualified or competent person.

Warning! This appliance must be earthed. The manufacture declines any liability should these safety measures not be observe.

Operation

Accessories ¹⁾

Movable shelves/trays

- Various glass or plastic storage shelves or wire trays are included with your appliance – different models have different combinations and different models have different quality.
- The walls of the refrigerator are equipped with a series of runners so that the shelves can be positioned as desired.

Positioning the door shelves

- To permit storage of food packages of various sizes, the door shelves can be placed at different heights.
- To make these adjustments proceed as follows gradually pull the shelf in the direction of the arrows until it comes free, then repositions as required.

Vegetable Drawer

- The drawer is suitable for storing fruit and vegetables.

Helpful hints and tips

Noises during Operation

The following noises are characteristic of refrigeration appliances:

Clicks Whenever the compressor switches on or off, a click can be heard.

Humming As soon as the compressor is in operation, you can hear it humming.

Bubbling When refrigerant flows into thin tubes, you can hear bubbling or splashing noises.

Splashing Even after the compressor has been switched off, this noise can be heard for a short time.

Energy saving tips

- Do not install the appliance near cookers, radiators or other sources of warmth.
- Do not open the door too often or leave the door open any longer than necessary.
- Do not set temperature colder than necessary.
- Make sure the side plates and back plate of the appliance are with some distance from the wall, follow the instructions relevant to installation.
- If sketch map shows the right combination of the drawers, crisper and shelves, do not adjust the combination, it would result in more energy-consuming.

Hints for fresh food refrigeration

To obtain the best performances:

- Do not store warm foods or evaporating liquids in the appliance.
- Do cover or wrap the food, particularly if it has a strong flavor.
- Position food so that air can circulate freely around.

Hints for refrigeration

- Meat(all types): wrap in polythene bags and place on the glass shelf above the vegetable drawer. For safety, store in this way only one or two days at the most.
- Cooked foods, cold dishes, etc...: these should be covered and may be placed on any shelf. Fruit and vegetables: these should be thoroughly cleaned and placed in the special draw(s) provided.
- Butter and cheese: these should be placed in aluminum foil or polythene bags to exclude as much air as possible .
- Milk bottles: these should have a cap and should be stored in the bottle rack on the door

Cleaning and Care

Cleaning and Care

For hygienic reasons the appliance interior, including interior accessories, should be cleaned regularly.

The fridge should be cleaned and maintained at least every two months.



Warning! Danger of electrical shock!

- The appliance should not be connected to the mains during cleaning. Before cleaning switch the appliance off and remove the plug from the mains, or switch off or turn out the circuit breaker or fuse.

Important!

- Remove the food from the appliance

before cleaning. Store them in a cool place, well covered.

- Never clean the appliance with a steam cleaner. Moisture could accumulate in electrical components,
- Hot vapors can lead to the damage of plastic parts.
- Ethereal oils and organic solvents can attack plastic parts, e.g. lemon juice or the juice from orange peel, butyric acid, cleanser that contain acetic acid. Do not allow such substances to come into contact with appliance parts.
- Do not use any abrasive cleansers.
- Clean the appliance and the interior accessories with a cloth and lukewarm

water. Commercially available dish washing detergents may also be used.

- After cleaning wipe with fresh water and clean dish cloth.
- Accumulation of dust at the condenser increases energy consumption, clean the condenser at the back of the appliance once a year with a soft brush or a vacuum cleaner.
- Check the water drain hole on the rear wall of the refrigerator compartment.
- Clear a blocked drain hole with the aid of something like soft green peg, be careful not to make any damage to the cabinet by sharp things.
- After everything is dry place appliance back into service.

Defrosting

Why defrosting

- Water contained in food or getting into air inside the fridge be opening doors may form a frost layer inside. It will weaken the refrigeration when the frost is thick. While it is more than 10mm thick, you should defrost.

Defrosting in fresh food storage compartment

- It is automatically controlled by switching the temperature regulator on or off so that there is no need of operation of defrosting. Water from defrosting will be drained into an drip tray through a drain pipe at the back of the fridge automatically.

Go out of use for a long time

- Remove all refrigerated packages.
- Switch off the appliance by turning the temperature regulator to position "0".
- Remove the mains plug or switch off or disconnect the electricity supply.
- Clean thoroughly (see section: Cleaning and Care)
- Leave the door open to avoid the build up of odors.

Note: If the appliance contains freezer compartment

Troubleshooting

 **Warning!** Before trouble shooting, disconnect the power supply. Only a qualified electrician of competent person must carry out the trouble shooting that is not in the manual.

Important! There are some sounds during normal use (compressor, refrigerant circulation)

Important!

Repairs to refrigerators/freezers may only be performed by competent service engineers. Improper repairs can give rise to significant hazards for the user. If your appliance needs repairing, please contact your specialist dealer or your local Service Force Center.

Problem	Possible cause	Solution
Appliance does not work.	Appliance is not switched on.	Switch on the appliance.
	Mains plug is not plugged in or is loose.	Insert mains plug.
	Fuse has blown or is defective.	Check fuse, replace if necessary.
	Socket is defective.	Mains malfunctions are to be corrected by an electrician.
Appliance cools too much.	Temperature is set too cold.	Turn the temperature regulator to a warmer setting temporarily.

The food is too warm.	Temperature is not properly adjusted.	Please look in the “initial Start Up” section.
	Door was open for an extended period.	Open the door only as long as necessary.
	A large quantity of warm food was placed in the appliance within the last 24 hours.	Turn the temperature regulation to a colder setting temporarily.
	The appliance is near a heat source.	Please look in the “installation location” section.
Interior lighting does not work.	Light bulb is defective.	Please look in the “changing the Light Bulb” section.
Heavy build-up of frost, possibly also on the door seal.	Door seal is not air-tight (possibly after reversing the door).	Carefully warm the leaking sections of the door seal with a hair dryer (on a cool setting). At the same time shape the warmed door seal by hand such that it sits correctly.
Unusual noises.	Appliance is not level.	Readjust the feet.
	The appliance is touching the wall or other objects.	Move the appliance slightly.
	A component, e.g. a pipe, on the rear of the appliance is touching another part of the appliance or the wall.	If necessary, carefully bend the component out of the way.
The compressor does not start immediately after changing the temperature setting.	This is normal, no error has occurred.	The compressor starts after a period of time.
Water on the floor or storage shelves.	Water drain hole is blocked.	See the “cleaning and care” section.

Changing the light bulb



Warning! If the light bulb is damaged, DO NOT CHANGE IT BY THE USER!

Changing the light bulb carry out by inexperienced persons may cause injury or serious malfunctioning, it must be replaced by a qualified persons in order to avoid a hazard. Contact your local Service Force Center for help.

- Before changing the light bulb, switch off the appliance and unplug it, or pull the fuse or the circuit breaker.
- Light bulb data: 220-240 V, max. 15W.

- To switch off the appliance, set the temperature regulator to position “0”.
- Unplug the mains plug
- To change the light bulb, undo the screw.
- Press the light bulb cover and slide it backwards.
- Change the defective light bulb.
- Refit the light bulb cover and the screw.
- Put the refrigerator back into operation.

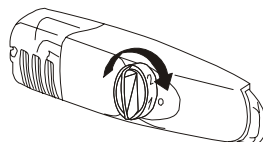

Description of the appliance

View of the appliance

- 1.Butter/cheese compartments with flap and egg storage insert
2. Door storage compartment
3. Bottle shelf
4. Temperature regulator
5. Storage shelves
6. Vegetable drawer cover
7. Vegetable drawer
8. Leveling leg

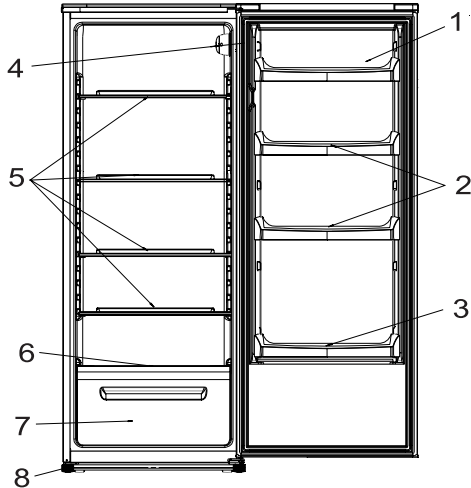

Note: Due to unceasing modification of our products your refrigerator may be slightly different from this Instruction Manual, but its functions and using methods remain the same.

Reversing the door

The side at which the door opens can be changed from the right side (as supplied) to the left side, if the installation site requires.

Tools you will need:

1. 8mm socket driver



2. cross-shaped screwdriver



3. Putty knife or thin-blade screwdriver



Before you start lay the refrigerator on it's back in order to gain access to the base, you should rest it on soft foam packaging or similar material to avoid damaging the cooling pipes at the rear of the refrigerator.

1. Stand the refrigerator, use a flat bladed screw driver to remove the 4 screw covers at the rear of the refrigerator lid.

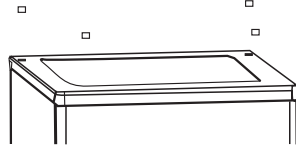

2. Unscrew and lift the lid from the rear and remove it, then lift the upper door and place it on a padded surface to prevent it scratched.

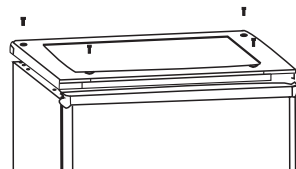

3. Use a flat bladed screw driver to remove the front ornament of top cover plate.

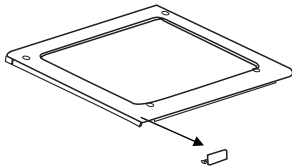

4. Replace the front ornament of top cover plate in the other side.

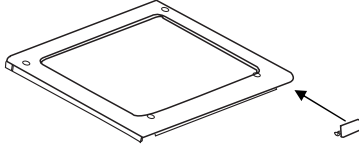

5. Remove the upper hinge core, transfer it to left side and tighten securely, then put it in a safe place.

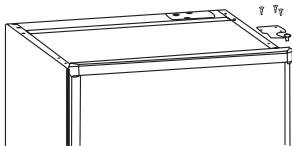

6. Remove both adjustable feet and remove the bottom hinge bracket by unscrewing the bolts.



7. Unscrew and remove the bottom hinge pin, turn the bracket over and replace it. Refit the bracket fitting the bottom hinge pin. Replace both adjustable feet. Transfer the lower door to the property position. Secure the door's level, make the bottom hinge pin into the lower hole of the door, then tight the bolts.

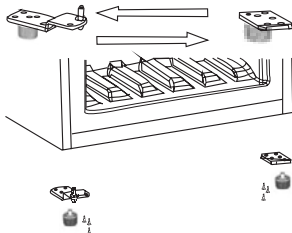

8. Replace the lid by fitting the upper hinge core into the upper door's hole, securing it with the 4 screws. Replace the screw covers.

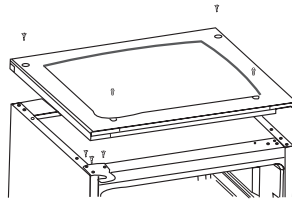

Warning!

When changing the side at which the door opens, the appliance must not be connected to the mains. Remove plug from the mains beforehand.

When you reverse the door, Please do this first:

1. Move the accessory **B** from the upper cover of upper door and fit the accessory **A** that is a small detachable part from a small bag.

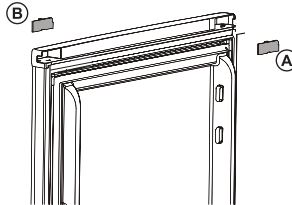

After you reverse the door ,please do this:

Move the handle from the left side of upper door to the right side .

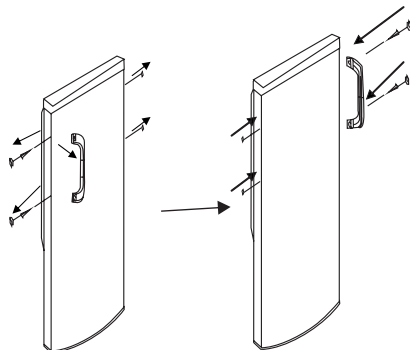

Disposal of the appliance



It is prohibited to dispose of this appliance in domestic household waste.

Packaging materials

Packaging materials with the recycle symbol are recyclable. Dispose of the packaging in a suitable waste collection container to recycle it.

Before disposal of the appliance.

1. Disconnect the main plug from the main socket.
2. Cut off the main cable and discard it.

	Correct Disposal of this product
 	<p>This marking indicates that this product should not be disposed with other household wastes throughout the EU. To prevent possible harm to the environment or human health from uncontrolled waste disposal, recycle it responsibly to promote the sustainable reuse of material resources. To return your used device, please use the return and collection systems or contact the retailer where the product was purchased. They can take this product for environmental safe recycling.</p>

Fridgemaster Technical Helpline and Service Centre - Telephone

0845 050 8536



FRIDGEMASTER
Unit 2 Meadow Court
Millshaw Lane Leeds,
West Yorkshire,
LS11 8LZ,
United Kingdom

For further information please contact
the Fridgemaster Technical Helpline on:
0845 0508536

Fridgemaster@0800repair.com



This symbol on the product or in the instructions means that your electrical and electronic equipment should be disposed at the end of its life separately from your household waste. There are separate collection systems for recycling in the EU. For more information, please contact the local authority or your retailer where you purchased the product.

